

Donaldson Airbus AS350 IBF

August 1, 2020

AS350

(B, BA, B1, B2, Be Single Hydraulic, AS350B3e Single Hydraulic)



AS350 IBF SYSTEM DESIGN

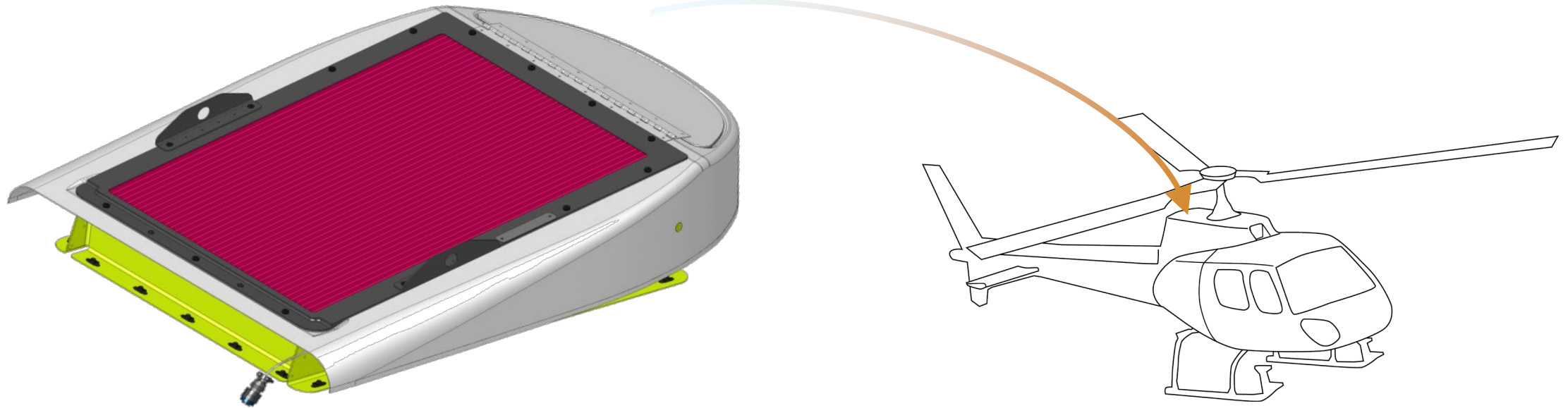

COMPATABILITY:

- Compatible with both Turbomeca Arriel and Honeywell LTS Engine Installations
- AS350 is equivalent to the H125 designation

AS350 IBF SYSTEM DETAILS

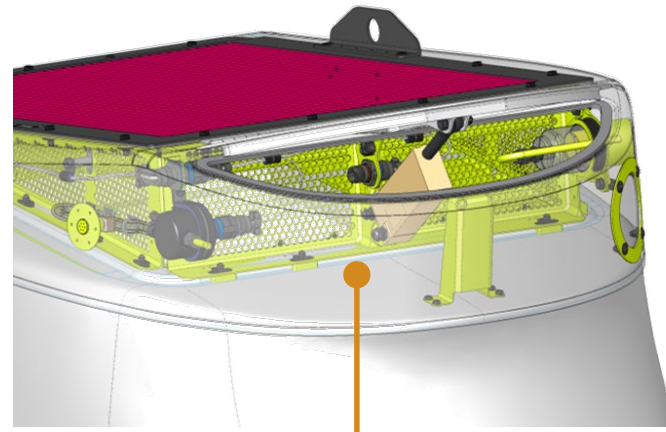
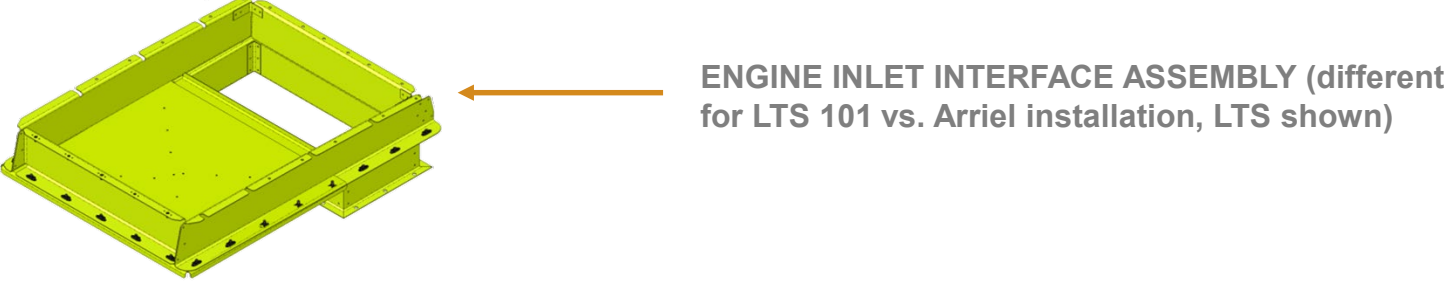
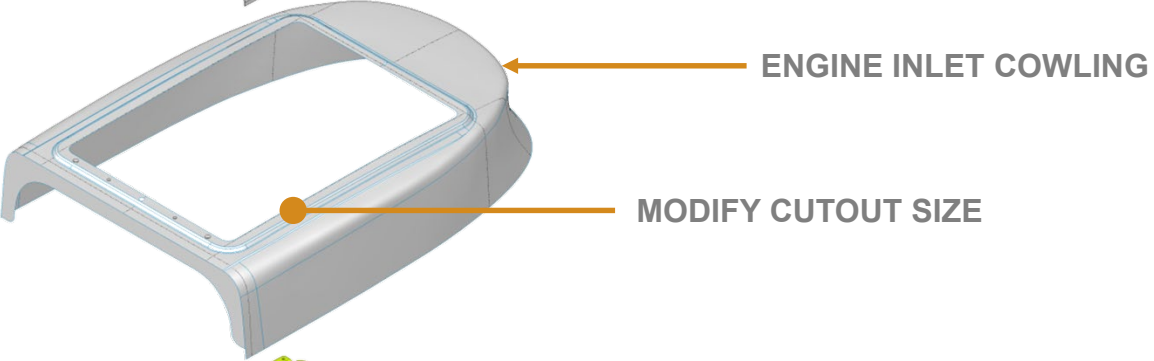
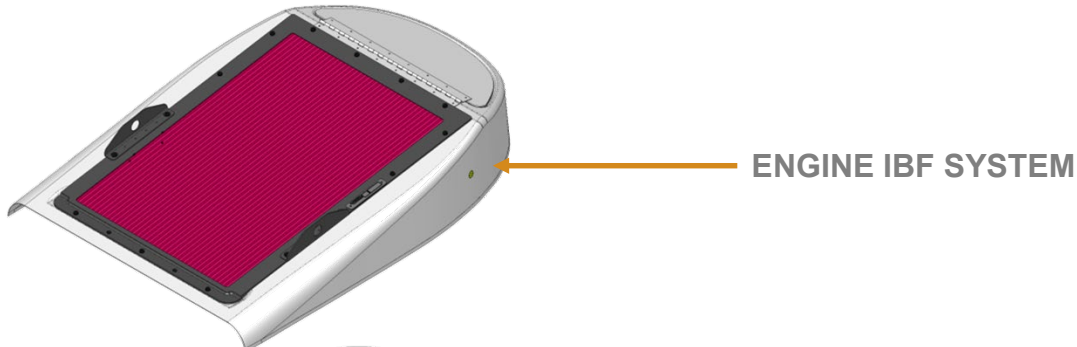

AS350 IBF ARRIEL INSTALLATION

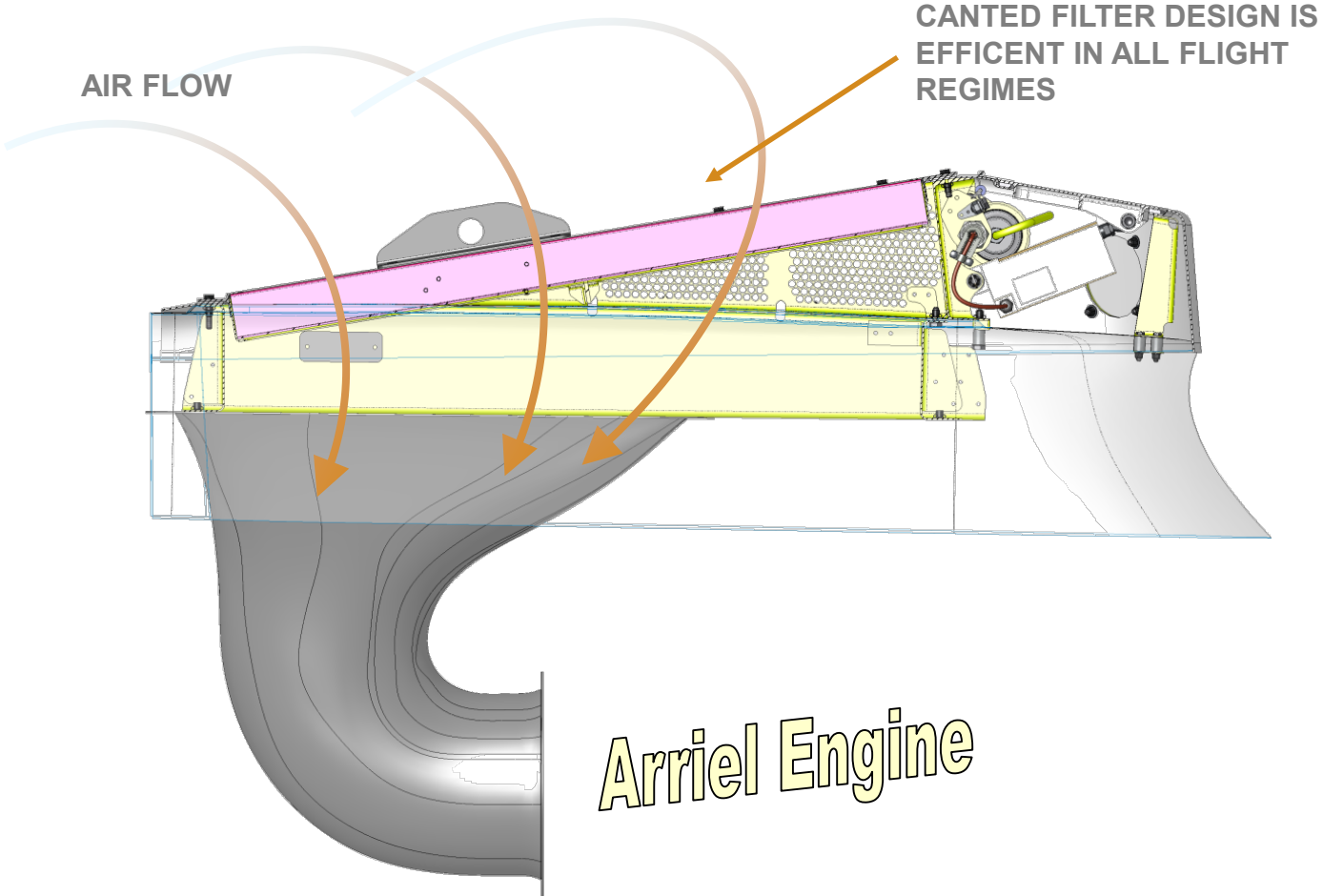

AS350 IBF LTS INSTALLATION

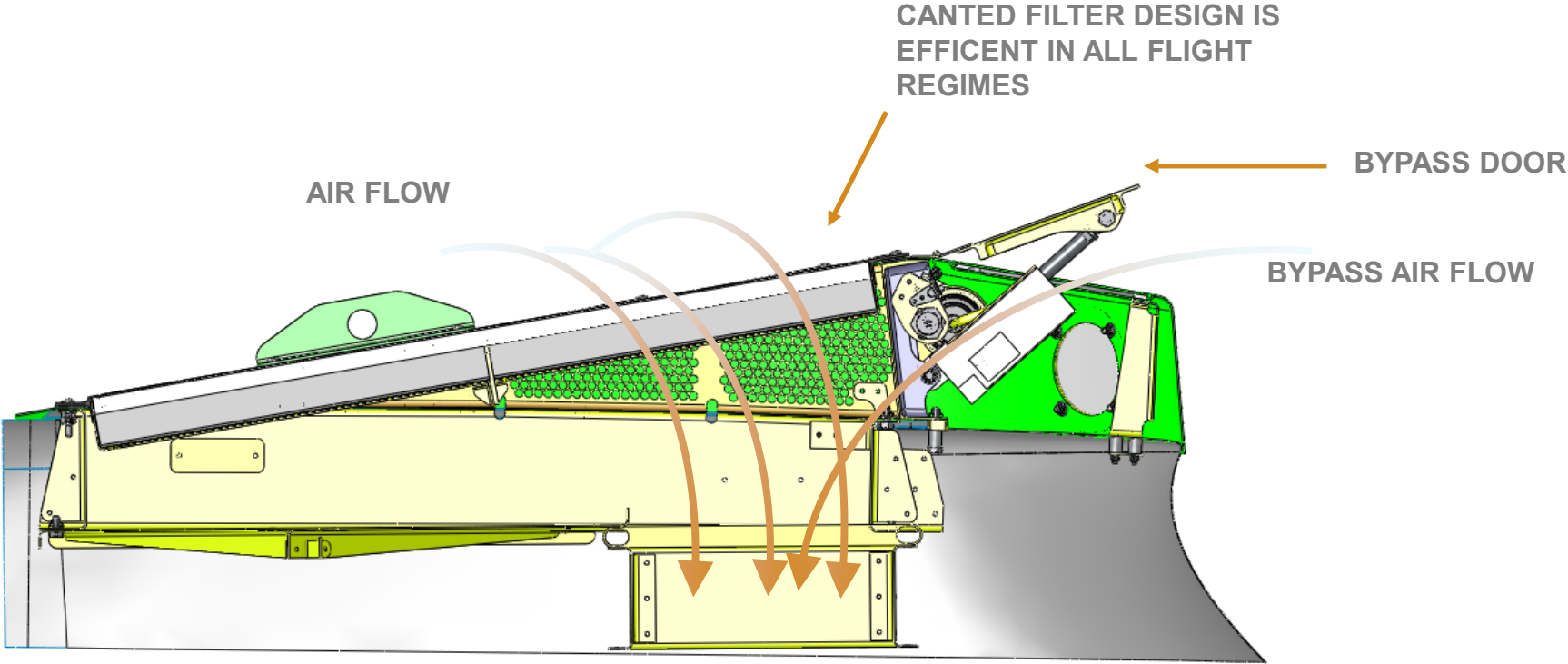

LTS Engine

AS350 IBF BYPASS MAJOR COMPONENTS

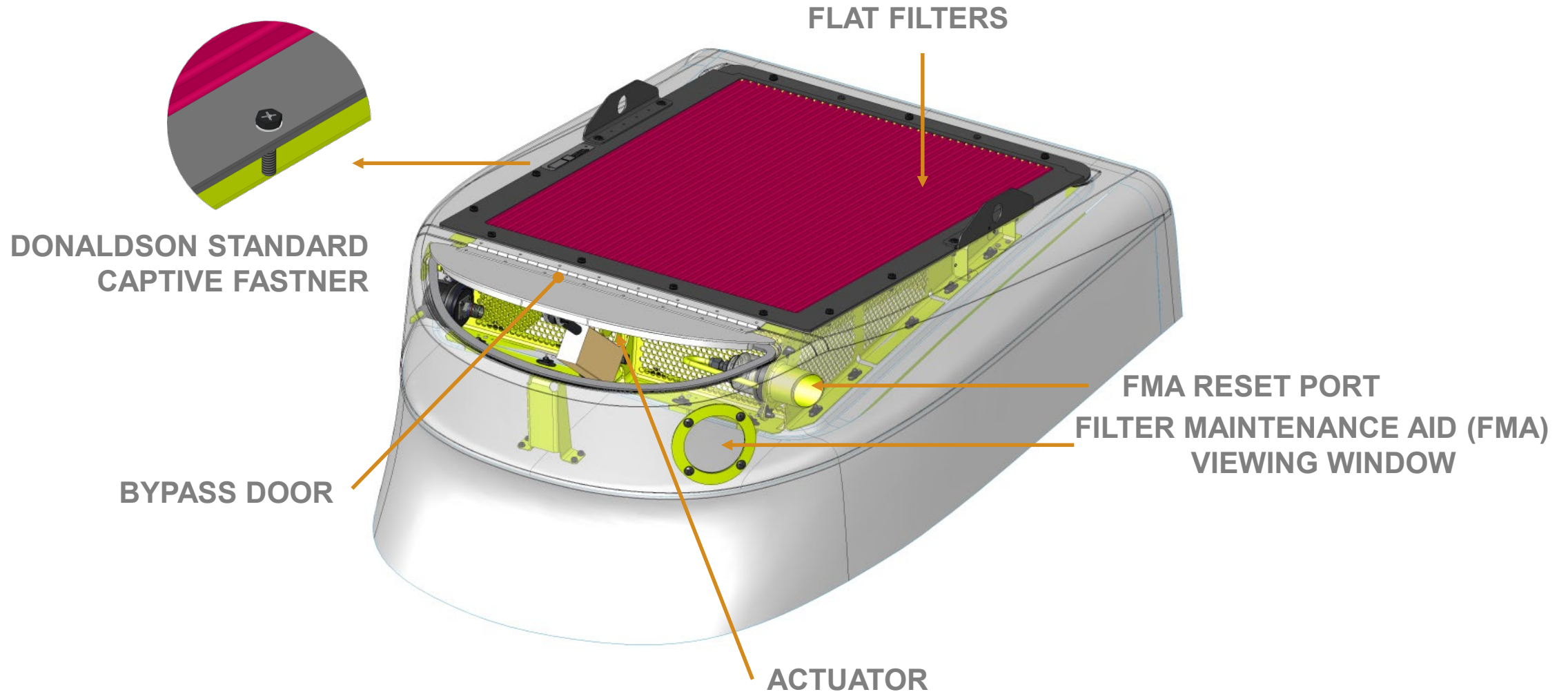

AS350 IBF FILTER BYPASS SYSTEM

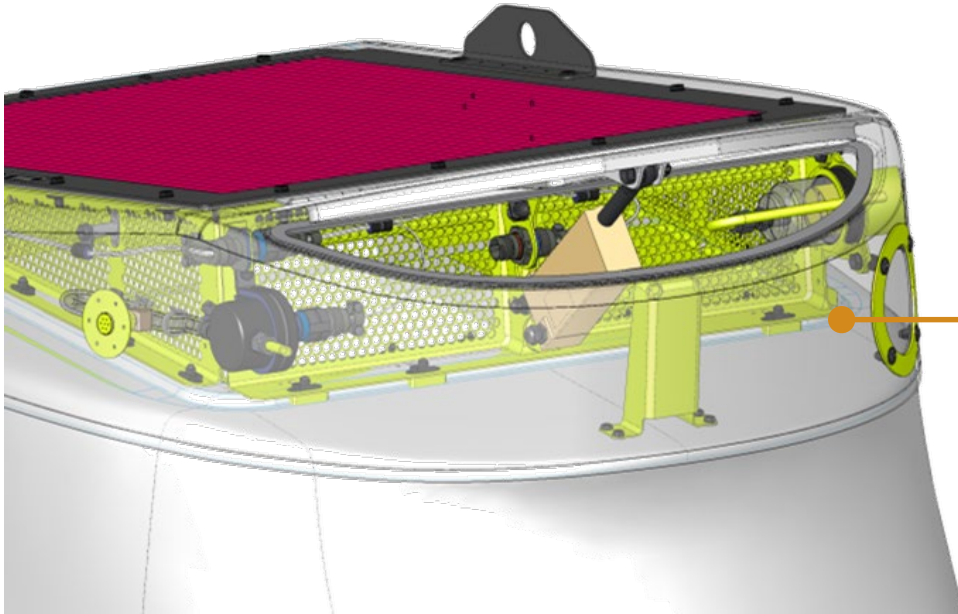

Pilot commands the bypass door to open to increase engine airflow until clear of debris conditions.

NOTE: Aircraft with particle separators must land immediately during heavy debris conditions and do not have the ability to keep flying like aircraft with a barrier filter bypass system.

IBF FILTER MAINTENANCE AID (FMA)

- Pre and Post flight indication of filter contamination level and maximum pressure drop.
- Allows flexibility for mission planning with predictable service cycles, particularly in high tempo desert environments.
- Verification of post cleaning effectiveness



IBF FILTER MAINTENANCE AID (FMA)

- Provides the ability to meet Condition-Based Maintenance (CBM) between established cleaning intervals, eliminating unnecessary service.
- Measures plenum pressure versus ambient, across the filter system.
- Similar FMA used on other Donaldson IBFs for the Bell 205A, 206B, 206L-1/3/4, 407, 430, Leonardo A119, AW139, AW189, Airbus EC130, MD Helicopters MD500.



IBF BENEFITS: PERFORMANCE

MAXIMUM ENGINE DEBRIS/FOD PROTECTION

Allows consistent flight operations and extends engine time on wing. Improved protection over an inertial design and significantly better protection than a FOD screen.

IMPROVED AIRFLOW

Pleated barrier filter element provides improved air flow versus inertial separation vortex/swirl tubes typical with IPS/EAPS.



IBF BENEFITS: VALUE

RETURN ON INVESTMENT (ROI)

- Less premature engine removals, meet the expected engine TBO
- Long-life 4,500 flight hour filter assemblies (15 cleanings; 300-hour intervals)
- Reduction in corrosive salt air entering engine
- Engine overhaul cost reduction due to elimination of erosion and contamination on all rotating and pneumatic components
- Reduced maintenance time with improved plenum access.
- Common Line Replaceable Units (LRU) for mixed IBF fleets.
- Bleed air system maintenance eliminated with IBF



IBF OPERATIONAL CONSIDERATIONS

- Improved power margin for high/hot operations and confined landing zones. Scavenge air not required, immediate performance improvement with IBF.
- Engine performance retention after barrier filter installation.
- Inlet air bypass system backup not available with EAPS; added safety feature.
- Certified for flight in falling and blowing snow IAW helicopter manufacturers flight manual
- Filter sized for B3 engine airflow



IBF COMPARATIVE BENEFITS

- Engine Air Particle Separators (EAPS) utilize traditional inertial particle separation technology. Barrier Filters (BF) use current technology and state of the art integration.
- BF does not require the use of engine bleed air. EAPS does require engine bleed air which reduces engine power available.
- Engine bleed air system maintenance is eliminated. Reduced chance of engine stall from leaking valves and lines.
- Inertial separation vortex/swirl tubes routinely become clogged with straw, leaves and bugs degrading performance; Barrier filter immune to this type debris clogging and operates without degradation.



IBF COMPARATIVE BENEFITS

- Barrier filters (BF) have significantly higher separation efficiency than inertial separators. BF typically >99% capture efficient on ISO Coarse & Fine dust, inertial separator typically <96% capture efficiency on ISO Coarse dust and far less on ISO Fine dust.
- BF are effective regardless of engine power setting; inertial separators (PS) are only effective when they have adequate engine bleed air; PS adequacy typically available above flight idle power setting.
- Significant decrease in fine sand ingestion reduces engine erosion damage from offsite landings/unprepared sites; BF virtually eliminate concern about ramp FOD ingestion.



Thank You

Donaldson Company, Inc.
Aerospace & Defense Group

www.DonaldsonAerospace-Defense.com

North America +1-877-314-9640
aerospace.americas@donaldson.com
Europe +33 1 30866698
aerospace.emea@donaldson.com



Donaldson.
FILTRATION SOLUTIONS
AEROSPACE & DEFENSE